



RoHS Compliant

CT1103

12 x 12 Thru-Hole Tactile

Specifications

Electrical Ratings	50mA @ 50VDC
Electrical Life	100,000 cycles typical
Contact Resistance	<50mΩ initial
Actuation Force	180 ± 50gF
Actuation Travel	.30 ± .1mm

Dielectric Strength	250Vrms min
Insulation Resistance	>100MΩ min
Operating Temperature	-40°C to 85°C
Storage Temperature	-40°C to 85°C

Materials

Actuator	6/6 Nylon
Housing	6/6 Nylon
Cover	Stainless Steel
Contacts	Phosphor Bronze, Silver Plated
Terminals	Brass, Silver Plated

Ordering Information

1. Series	CT1103	G	F180	C141
CT1103				
2. Actuator Options				
A				
B				
C				
T				
G				
E				
3. Actuation Force:				
F180 = 180gF				
4. Cap		Cap Colors:		
C11	C19			
C12	C22	**See Cap Options for color availability		
C13	C26	**Caps available with G actuator only		
C16	C27			
C18	C28			

Dimensions

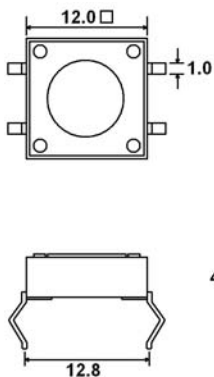

CT1103A

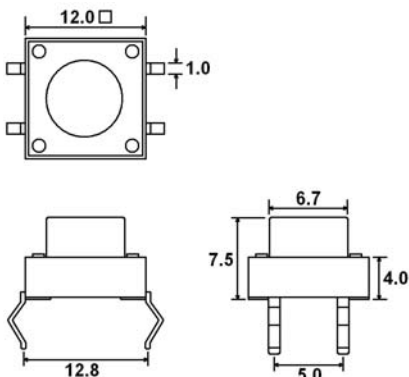

CT1103B

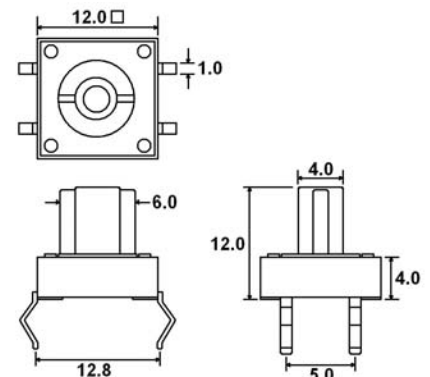

CT1103C

CT1103

12 x 12 Thru-Hole Tactile

Dimensions

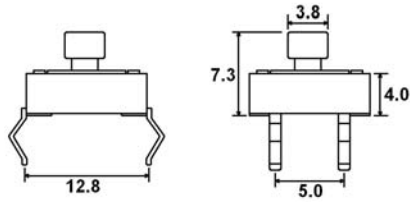
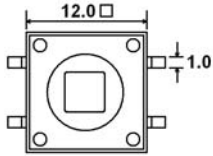

CT1103T

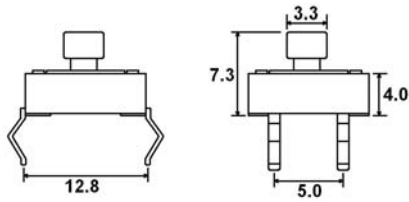
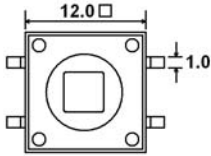

CT1103G

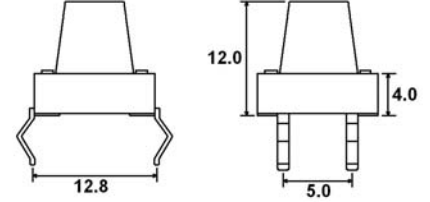
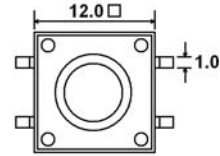

CT1103E

Schematic & PC Layout

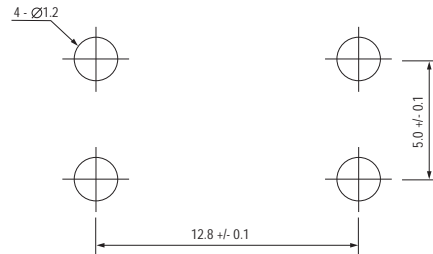
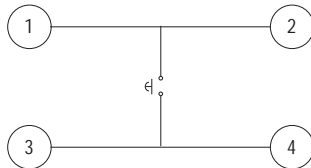

Cap Options for G Actuator

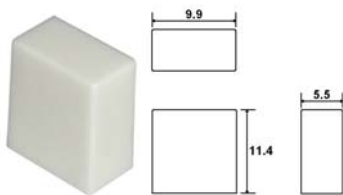

C11

1 = White, 2 = Black, 3 = Red, 9 = Light Gray
Contact Factory for other available colors

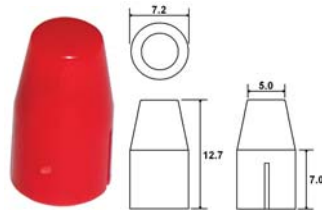

C12

1 = White, 2 = Black, 3 = Red, 9 = Light Gray
Contact Factory for other available colors

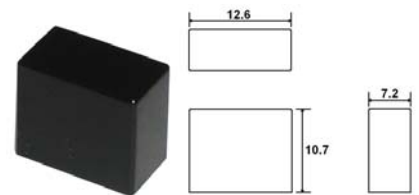

C13

1 = White, 2 = Black, 3 = Red, 9 = Light Gray
Contact Factory for other available colors

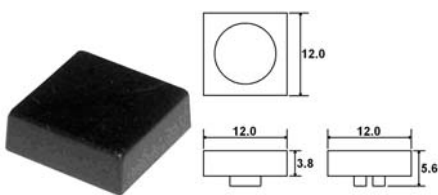

C16

1 = White, 2 = Black, 3 = Red, 7 = Blue
Contact Factory for other available colors

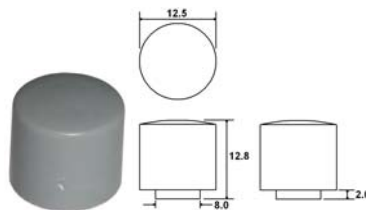

C18

1 = White, 2 = Black, 3 = Red, 9 = Light Gray
Contact Factory for other available colors

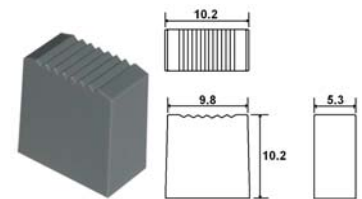

C19

1 = White, 2 = Black, 3 = Red, 8 = Dark Gray
Contact Factory for other available colors

Cap Options for G Actuator

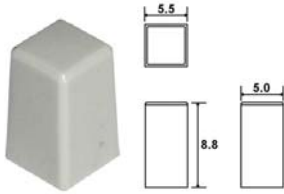

C22_

2 = Black, 8 = Dark Gray, 9 = Light Gray
 Contact Factory for other available colors

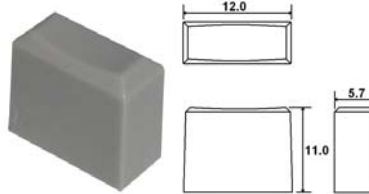

C26_

1 = White, 2 = Black, 3 = Red, 9 = Light Gray
 Contact Factory for other available colors

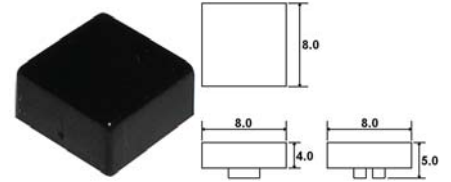

C27_

1 = White, 2 = Black, 3 = Red, 9 = Light Gray
 Contact Factory for other available colors

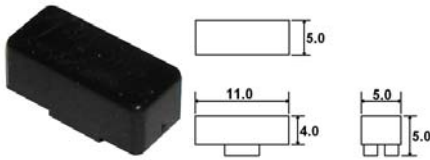

C28_

1 = White, 2 = Black, 3 = Red
 Contact Factory for other available colors